

FEATURES

- V_{CEsat} with positive temperature coefficient
- Low V_{CEsat}
- Low switching losses
- Low inductance case
- 10 μ s short circuit capability
- Isolated copper baseplate using DBC technology

IGBT

$V_{CES} = 1200V$
 $I_{C\ nom} = 25A / I_{CRM} = 50A$

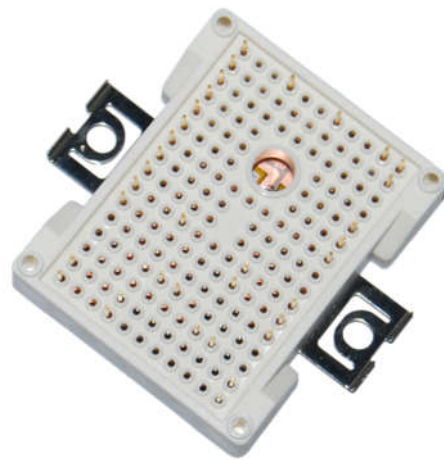

APPLICATION

- Inverter for motor drive Inverter
- Air Conditioning
- Auxiliary inverters
- Uninterruptible power supply

Equivalent Circuit Schematic

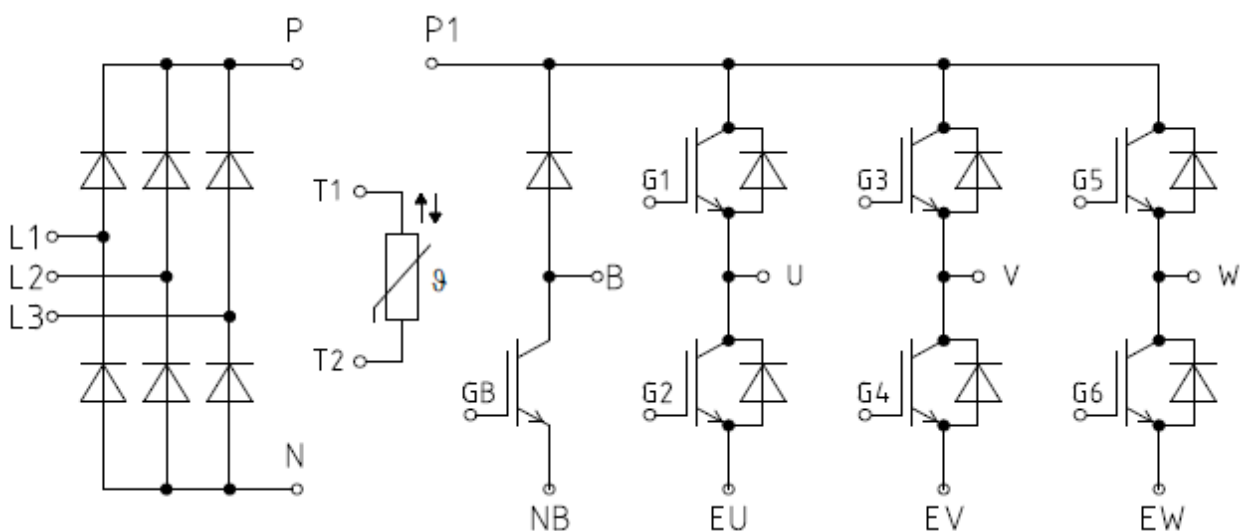

IGBT, Inverter Maximum Rated Values

Parameter	Conditions	Symbol	Values	Units
Collector-emitter voltage	$T_{vj} = 25^{\circ}\text{C}$	V_{CES}	1200	V
Continuous DC collector current	$T_C = 95^{\circ}\text{C}$, $T_{vj} \text{ max} = 175^{\circ}\text{C}$	$I_{C \text{ nom}}$	25	A
Repetitive peak collector current	$t_p = 1 \text{ ms}$	I_{CRM}	50	A
Total power dissipation	$T_C = 25^{\circ}\text{C}$, $T_{vj} \text{ max} = 175^{\circ}\text{C}$	P_{tot}	190	W
Gate-emitter peak voltage		V_{CES}	± 20	V

Characteristic Values

Parameter	Conditions	Symbol	Values			Units
			Min.	Typ.	Max.	
Collector-emitter saturation voltage	$I_C = 25 \text{ A}$, $V_{GE} = 15 \text{ V}$ $T_{vj} = 25^{\circ}\text{C}$ $T_{vj} = 125^{\circ}\text{C}$	$V_{CE \text{ sat}}$		1.90 2.15		V V
Gate threshold voltage	$I_C = 0.48 \text{ mA}$, $V_{CE} = V_{GE}$, $T_{vj} = 25^{\circ}\text{C}$	V_{GEth}		6		V
Gate charge	$V_{GE} = -15 / 15 \text{ V}$	Q_G		0.1		μC
Input capacitance	$f = 1 \text{ MHz}$, $T_{vj} = 25^{\circ}\text{C}$, $V_{CE} = 25 \text{ V}$, $V_{GE} = 0 \text{ V}$	C_{ies}		1.79		nF
Reverse transfer capacitance	$f = 1 \text{ MHz}$, $T_{vj} = 25^{\circ}\text{C}$, $V_{CE} = 25 \text{ V}$, $V_{GE} = 0 \text{ V}$	C_{res}		0.08		nF
Collector-emitter cut-off current	$V_{CE} = 1200 \text{ V}$, $V_{GE} = 0 \text{ V}$, $T_{vj} = 25^{\circ}\text{C}$	I_{CES}			1.0	mA
Gate-emitter leakage current	$V_{CE} = 0 \text{ V}$, $V_{GE} = 20 \text{ V}$, $T_{vj} = 25^{\circ}\text{C}$	I_{GES}			400	nA
SC data	$V_{GE} \leq 15 \text{ V}$, $V_{CC} = 800 \text{ V}$ $V_{CEmax} = V_{CES} - LS_{CE} \cdot di/dt$ $t_p \leq 10 \mu\text{s}$, $T_{vj} = 25^{\circ}\text{C}$	I_{SC}		100		A
Thermal resistance, junction to case	per IGBT	R_{thJC}		0.8	0.9	K/W
Thermal resistance, case to heatsink	per IGBT $\lambda_{paste} = 1 \text{ W}/(\text{m}\cdot\text{K})$ / $\lambda_{grease} = 1 \text{ W}/(\text{m}\cdot\text{K})$	R_{thCH}		0.8		K/W
Temperature under switching conditions		$T_{vj \text{ op}}$	-40		150	$^{\circ}\text{C}$
Turn-on delay time, inductive load	$I_C = 25 \text{ A}$, $V_{CE} = 600 \text{ V}$ $V_{GE} = -15 / 15 \text{ V}$, $R_G = 15 \Omega$ $T_{vj} = 25^{\circ}\text{C}$ $T_{vj} = 125^{\circ}\text{C}$	$t_{d \text{ on}}$		0.01 0.01		μs
Rise time, inductive load		t_r		0.02 0.02		μs
Turn-off delay time, inductive load		$t_{d \text{ off}}$		0.11 0.10		μs
Fall time, inductive load		t_f		0.21 0.25		μs
Turn-on energy loss per pulse		E_{on}		1.72 1.81		mJ
Turn-off energy loss per pulse		E_{off}		1.20 1.56		mJ

Diode, Inverter Maximum Rated Values

Parameter	Conditions	Symbol	Values	Units
Repetitive peak reverse voltage	T _{vj} = 25°C	V _{RRM}	1200	V
Continuous DC forward current		I _F	25	A
Repetitive peak forward current	t _p = 1 ms	I _{FRM}	50	A

Characteristic Values

Parameter	Conditions	Symbol	Values			Units
			Min.	Typ.	Max.	
Forward voltage	I _F = 25 A, V _{GE} = 0 V T _{vj} = 25°C T _{vj} = 125°C	V _F		1.95 1.85		V
Peak reverse recovery current	I _F = 25 A, -d _{iF} /d _t = 1200 A/μs (T _{vj} =150°C) V _R = 600 V, V _{GE} = -15 V T _{vj} = 25°C T _{vj} = 125°C	I _{RM}		43 46		A
Recovered charge		Q _r		1.5 2.8		μC
Reverse recovery energy		E _{rec}		0.95 1.70		mJ
Thermal resistance, junction to case	per diode	R _{thJC}		0.9	1.05	K/W
Thermal resistance, case to heatsink	per diode I _{Paste} = 1 W/(m·K) / I _{grease} = 1 W/(m·K)	R _{thCH}		0.82		K/W
Temperature under switching conditions		T _{vj op}	-40		150	°C

Diode, Rectifier Maximum Rated Values

Parameter	Conditions	Symbol	Values	Units
Repetitive peak reverse voltage	T _{vj} = 25°C	V _{RRM}	1600	V
Average Output Current	50Hz/60Hz,sine wave	I _O	60	A
Surge forward current	t _p = 10 ms, T _{vj} = 25°C	I _{FSM}	440	A
I ² t - value	t _p = 10 ms, T _{vj} = 25°C	I ² t	960	A ² s

Characteristic Values

Parameter	Conditions	Symbol	Values			Units
			Min.	Typ.	Max.	
Forward voltage	T _{vj} = 25°C, I _F = 15 A	V _F		1.02		V
Reverse current	T _{vj} = 25°C, V _R = 1600 V	I _R			1.0	mA
Thermal resistance, junction to case	per diode	R _{thJC}		1.1	1.2	K/W
Thermal resistance, case to heatsink	per diode I _{Paste} = 1 W/(m·K) / I _{grease} = 1 W/(m·K)	R _{thCH}		1		K/W
Temperature under switching conditions		T _{vj op}	-40		150	°C

IGBT, Brake-Chopper Maximum Rated Values

Parameter	Conditions	Symbol	Values	Units
Collector-emitter voltage	$T_{vj} = 25^{\circ}\text{C}$	V_{CES}	1200	V
Continuous DC collector current	$T_C = 95^{\circ}\text{C}$, $T_{vj} \text{ max} = 175^{\circ}\text{C}$	$I_{C \text{ nom}}$	25	A
Repetitive peak collector current	$t_p = 1 \text{ ms}$	I_{CRM}	50	A
Gate-emitter peak voltage		V_{GES}	± 20	V

Characteristic Values

Parameter	Conditions	Symbol	Values			Units
			Min.	Typ.	Max.	
Collector-emitter saturation voltage	$I_C = 15 \text{ A}$, $V_{GE} = 15 \text{ V}$ $T_{vj} = 25^{\circ}\text{C}$ $T_{vj} = 125^{\circ}\text{C}$	$V_{CE \text{ sat}}$		1.85 2.10		V
Gate threshold voltage	$I_C = 0.48 \text{ mA}$, $V_{CE} = V_{GE}$, $T_{vj} = 25^{\circ}\text{C}$	$V_{G\text{Eth}}$		6.0		V
Gate charge	$V_{GE} = -15 / 15 \text{ V}$	Q_G		0.1		μC
Input capacitance	$f = 1 \text{ MHz}$, $T_{vj} = 25^{\circ}\text{C}$, $V_{CE} = 25 \text{ V}$, $V_{GE} = 0 \text{ V}$	C_{ies}		1.79		nF
Reverse transfer capacitance	$f = 1 \text{ MHz}$, $T_{vj} = 25^{\circ}\text{C}$, $V_{CE} = 25 \text{ V}$, $V_{GE} = 0 \text{ V}$	C_{res}		0.08		nF
Collector-emitter cut-off current	$V_{CE} = 1200 \text{ V}$, $V_{GE} = 0 \text{ V}$, $T_{vj} = 25^{\circ}\text{C}$	I_{CES}			1.0	mA
Gate-emitter leakage current	$V_{CE} = 0 \text{ V}$, $V_{GE} = 20 \text{ V}$, $T_{vj} = 25^{\circ}\text{C}$	I_{GES}			400	nA
SC data	$V_{GE} \leq 15 \text{ V}$, $V_{CC} = 800 \text{ V}$ $V_{CE\text{max}} = V_{CES} - L_{SCE} \cdot di/dt$ $t_p \leq 10 \mu\text{s}$, $T_{vj} = 25^{\circ}\text{C}$	I_{SC}		100		A
Thermal resistance, junction to case	per IGBT	R_{thJC}		0.8	0.9	K/W
Thermal resistance, case to heatsink	per IGBT $\lambda_{\text{paste}} = 1 \text{ W}/(\text{m}\cdot\text{K})$ / $\lambda_{\text{grease}} = 1 \text{ W}/(\text{m}\cdot\text{K})$	R_{thCH}		0.8		K/W
Temperature under switching conditions		$T_{vj \text{ op}}$	-40		150	$^{\circ}\text{C}$
Turn-on delay time, inductive load	$I_C = 15 \text{ A}$, $V_{CE} = 600 \text{ V}$ $V_{GE} = -15 / 15 \text{ V}$, $R_G = 15\Omega$ $T_{vj} = 25^{\circ}\text{C}$ $T_{vj} = 125^{\circ}\text{C}$	$t_{d \text{ on}}$		0.004 0.004		μs
Rise time, inductive load		t_r		0.032 0.036		μs
Turn-off delay time, inductive load		$t_{d \text{ off}}$		0.128 0.144		μs
Fall time, inductive load		t_f		0.17 0.21		μs
Turn-on energy loss per pulse		E_{on}		1.88 2.05		mJ
Turn-off energy loss per pulse		E_{off}		1.33 1.45		mJ

Diode, Brake-Chopper Maximum Rated Values

Parameter	Conditions	Symbol	Values	Units
Repetitive peak reverse voltage	$T_{vj} = 25^{\circ}\text{C}$	V_{RRM}	1200	V
Continuous DC forward current		I_F	15	A
Repetitive peak forward current	$t_p = 1 \text{ ms}$	I_{FRM}	30	A

Characteristic Values

Parameter	Conditions	Symbol	Values			Units
			Min.	Typ.	Max.	
Forward voltage	$I_F = 10 \text{ A}, V_{GE} = 0 \text{ V}$ $T_{vj} = 25^{\circ}\text{C}$ $T_{vj} = 125^{\circ}\text{C}$	V_F		1.95 2.0		V
Peak reverse recovery current	$V_R = 600 \text{ V}, I_F = 10 \text{ A},$ $V_{GE} = -15 \text{ V}$ $T_{vj} = 25^{\circ}\text{C}$ $T_{vj} = 125^{\circ}\text{C}$	I_{RM}		14.5 13.6		A
Recovered charge		Q_r		0.76 0.85		μC
Reverse recovery energy		E_{rec}		0.30 0.35		mJ
Thermal resistance, junction to case	per diode	R_{thJC}		1.68	1.8	K/W
Thermal resistance, case to heatsink	per diode $l_{paste} = 1 \text{ W}/(\text{m}\cdot\text{K}) / l_{grease} = 1 \text{ W}/(\text{m}\cdot\text{K})$	R_{thCH}		1.2		K/W
Temperature under switching conditions		$T_{vj op}$	-40		150	$^{\circ}\text{C}$

NTC-Thermistor Characteristic Values

Parameter	Conditions	Symbol	Values			Units
			Min.	Typ.	Max.	
Rated resistance	$T_{NTC} = 25^{\circ}\text{C}$	R_{25}		5		$\text{k}\Omega$
Deviation of R100	$T_{NTC} = 100^{\circ}\text{C}, R_{100} = 493 \Omega$	$\Delta R/R$	-5		5	%
Power dissipation	$T_{NTC} = 25^{\circ}\text{C}$	P_{25}			20	Mw
B-value	$R_2 = R_{25} \exp [B_{25/50}(1/T_2 - 1/(298,15 \text{ K}))]$	$B_{25/50}$		3380		K

Module

Maximum Rated Values

Parameter	Conditions	Symbol	Values	Units
Isolation test voltage	RMS, f = 50 Hz, t = 1 min.	VISOL	2.5	kV
Internal isolation	basic insulation (class 1, IEC 61140)		Al ₂ O ₃	
Creepage distance	terminal to heatsink terminal to terminal		11.5 6.3	mm
Clearance	terminal to heatsink terminal to terminal		10 5	mm
Comperative tracking index		CTI	>200	

Characteristic Values

Parameter	Conditions	Symbol	Values			Units
			Min.	Typ.	Max.	
Stray inductance module and fixture		L _{sCE}		30		nH
Module lead resistance, terminals - chip	TC = 25°C, per switch	R _{CC'+EE'} R _{AA'+CC'}		5 6		mΩ
Storage temperature		T _{stg}	-40		125	°C
mountig force per clamp		F	40		80	N
Weight		G		39		g

Fig. 1 output characteristic IGBT, Inverter

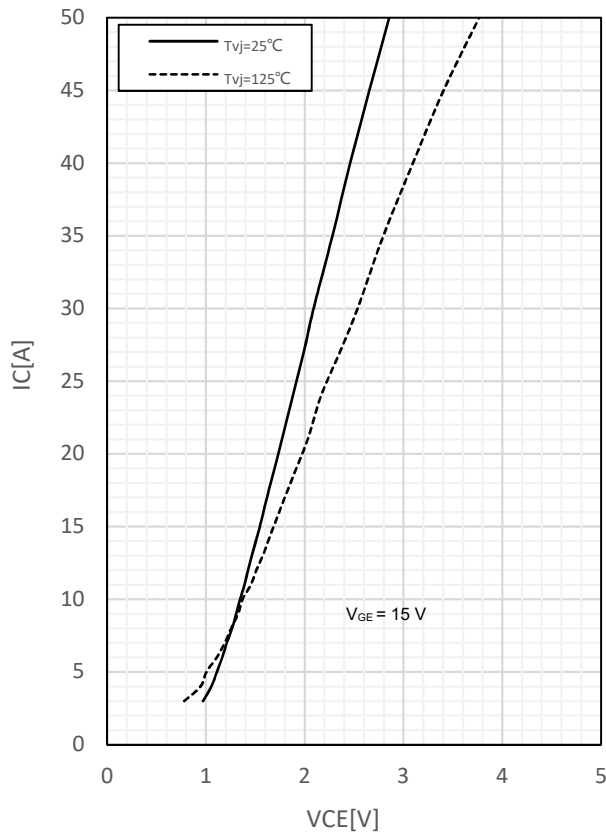

Fig.2 output characteristic IGBT, Inverter

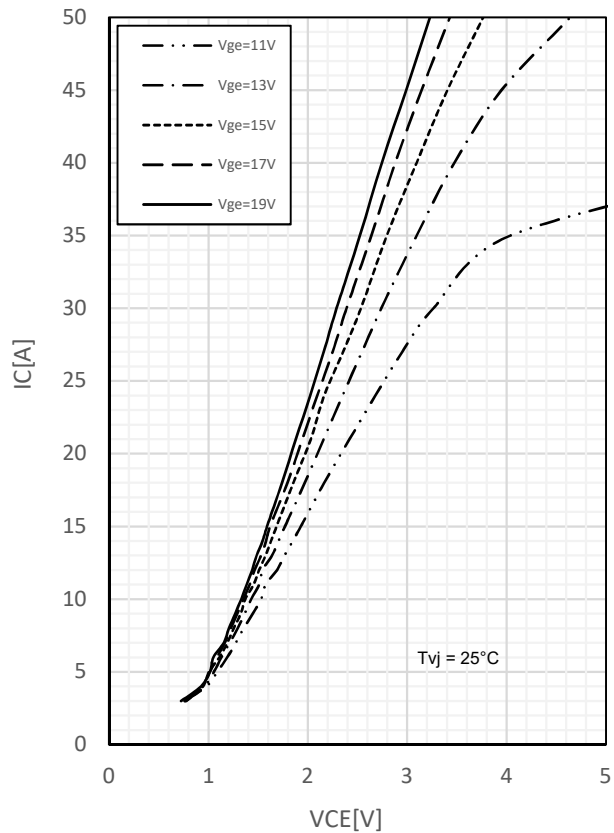

Fig. 3 transfer characteristic IGBT, Inverter

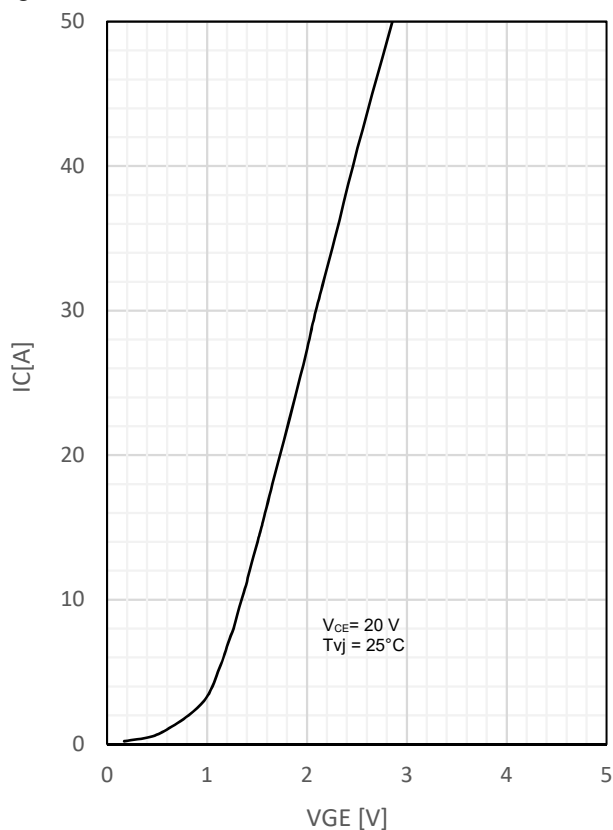

Fig. 4 switching losses IGBT, Inverter

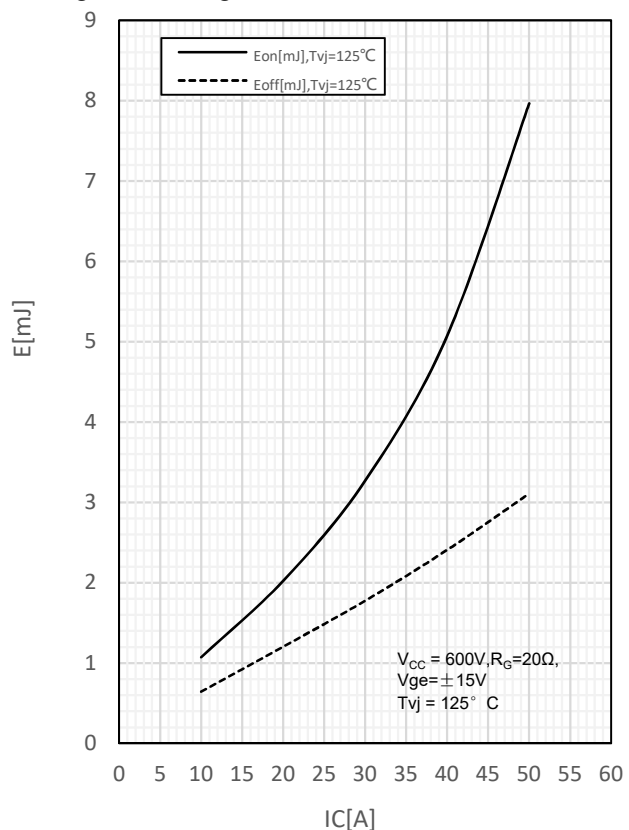

Fig. 5 switching losses IGBT, Inverter

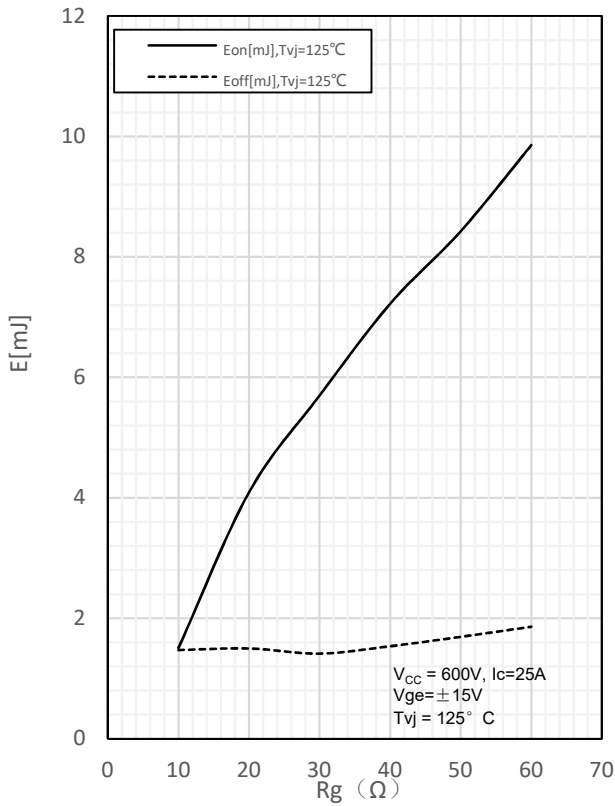

Fig. 6 transient thermal impedance IGBT, Inverter

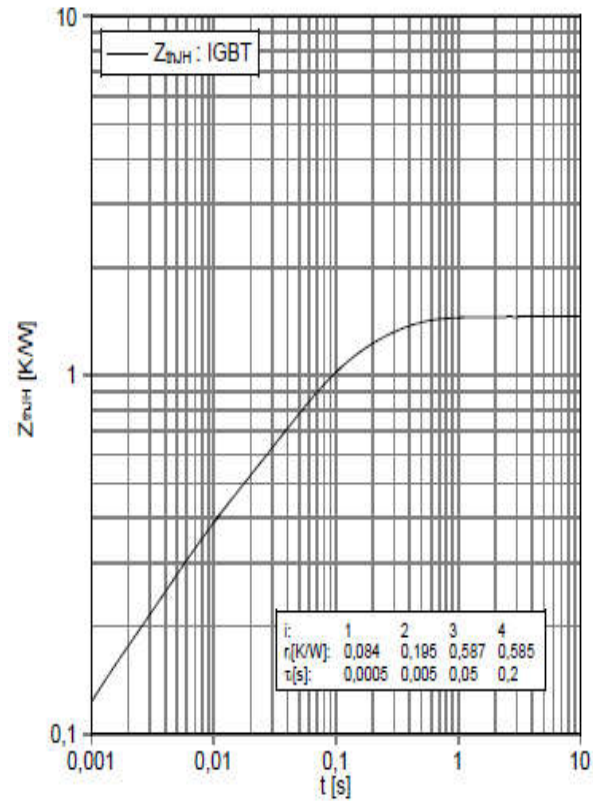

Fig. 7 NTC-Thermistor-temperature characteristic

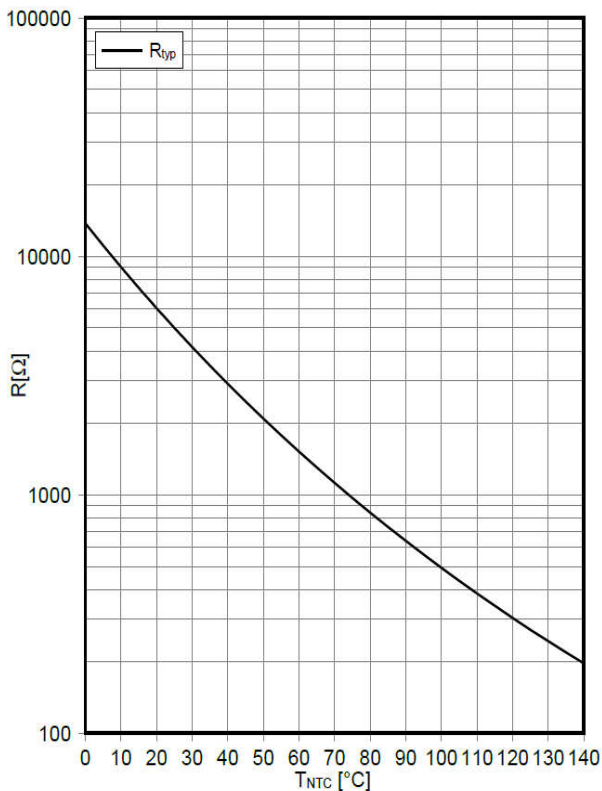

Fig. 8 forward characteristic of Diode, Inverter

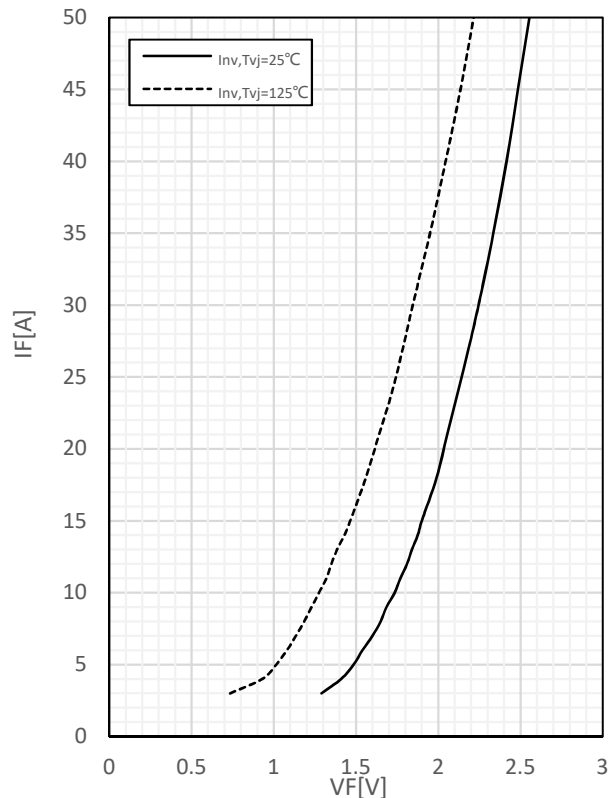

Fig. 9 switching losses Diode, Inverter

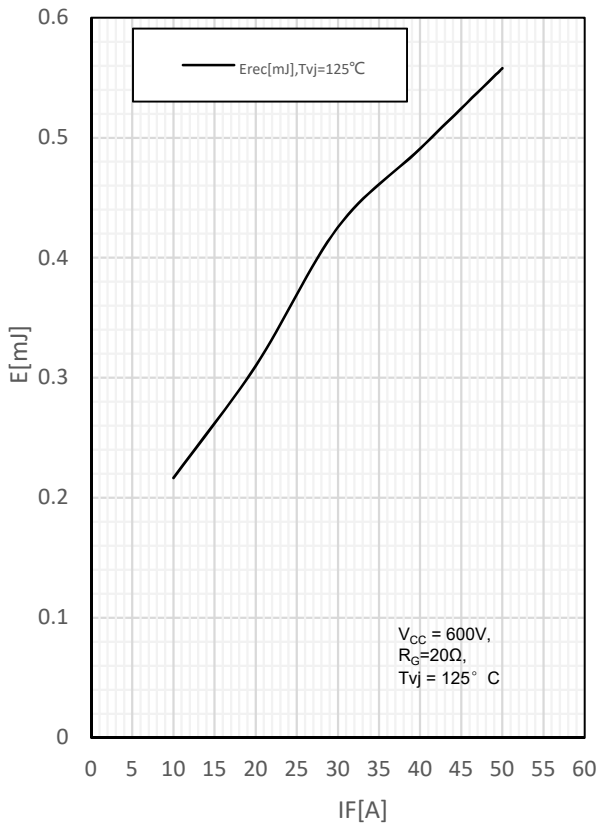

Fig. 10 switching losses Diode, Inverter

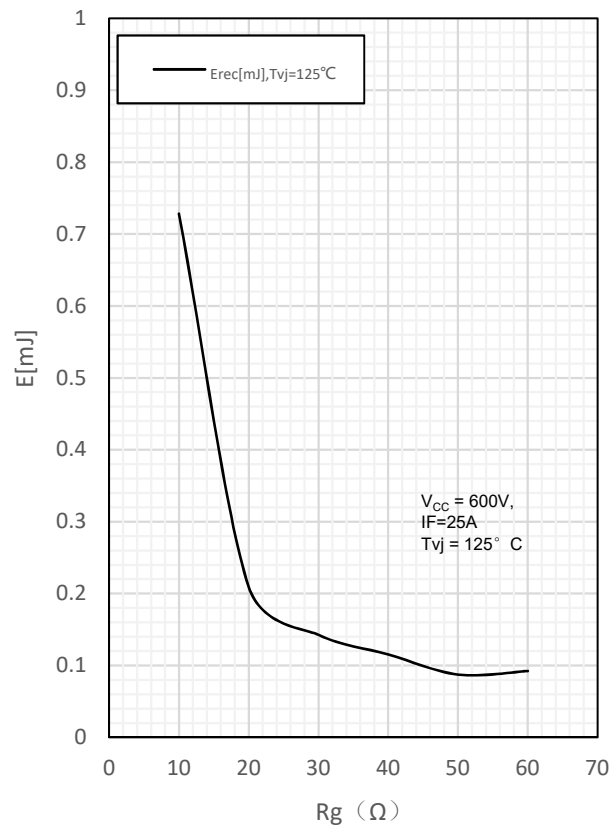

Fig. 11 transient thermal impedance Diode, Inverter

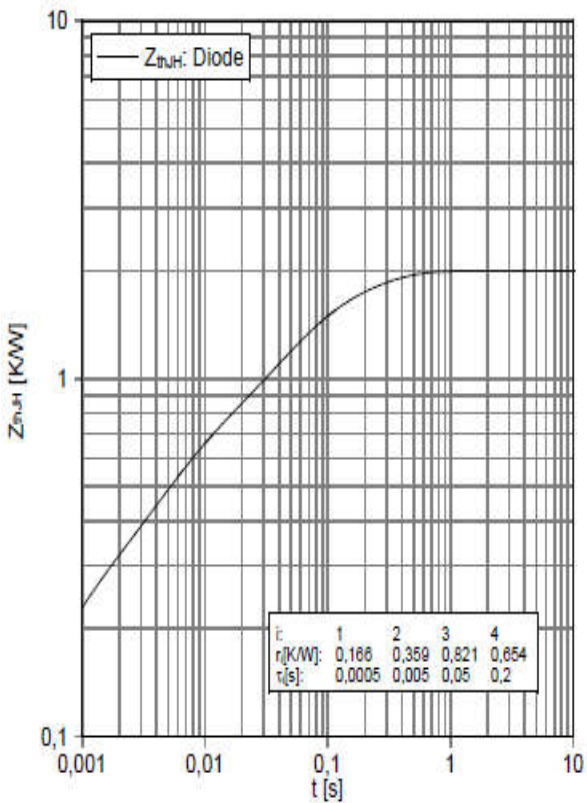

Fig. 12 forward characteristic of Diode, Rectifier

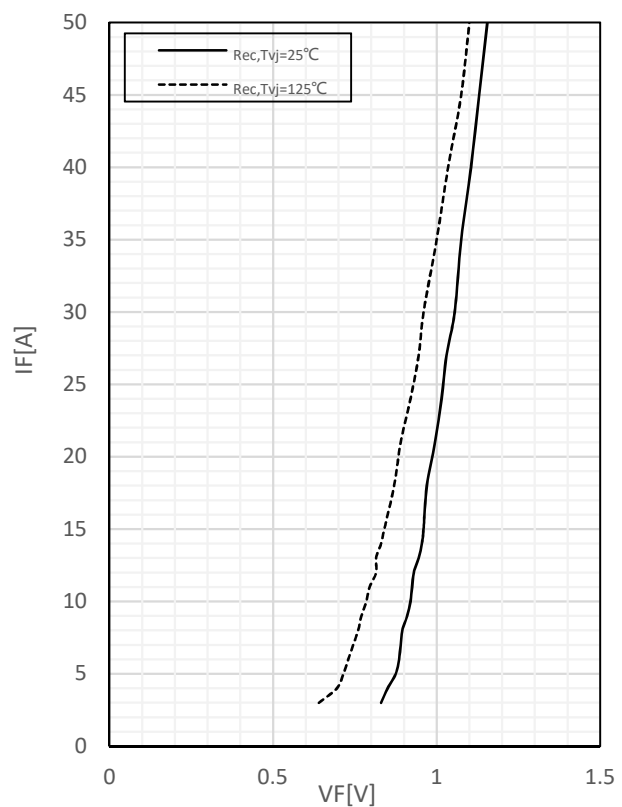

Fig. 13 output characteristic IGBT, Brake-Chopper

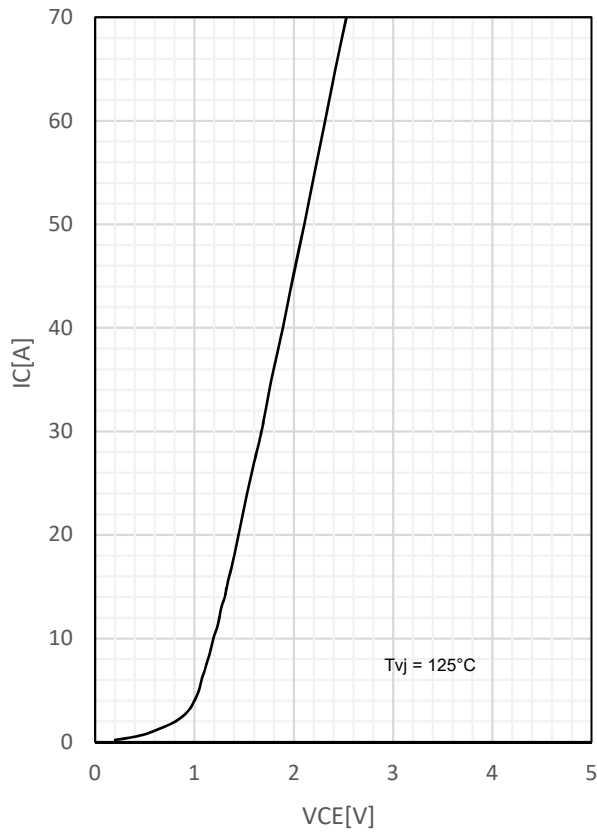
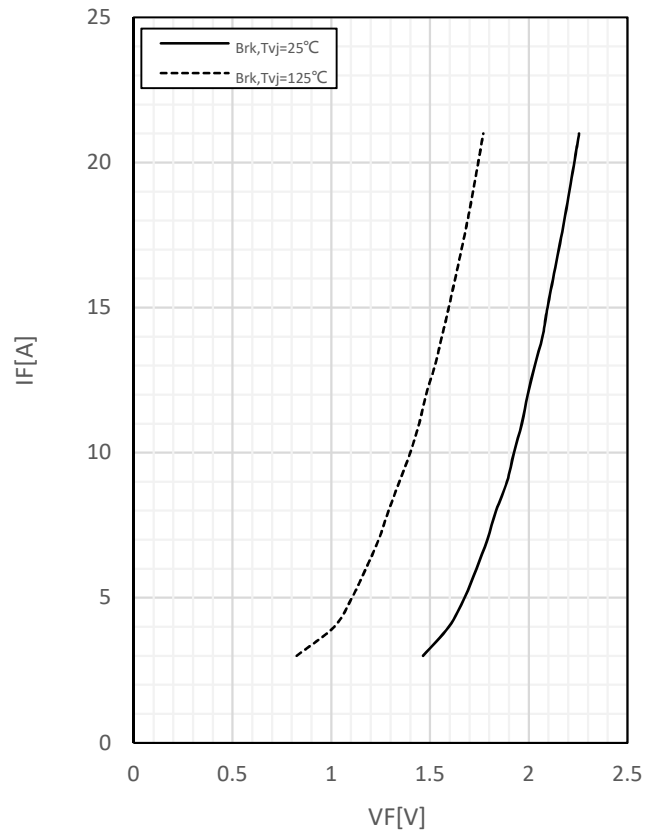
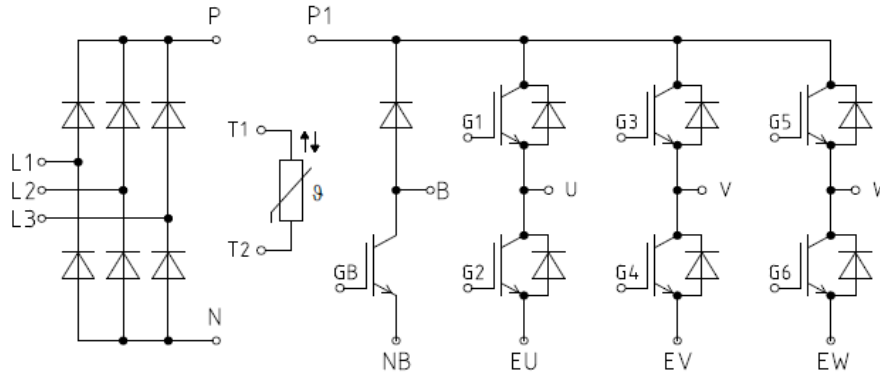

Fig. 14 forward characteristic of Diode, Brake-Chopper



Circuit diagram



Package outlines (mm)

